



T-349-A



T-352-A











T-350-01-A

TEK
T
N
E

Inset BRACKETS
the adjustable solution

The Inset Bracket Advantage

-  Self Locating for Easy Mounting
-  Works with Flush Bottom Cabinets (Universal Only)
-  Smooth Horizontal Adjustment
-  Anti-Slip Die Cast Insert
-  Made with Strong Glass Filled Polycarbonate
-  Attractive Wood Tone Coloring
-  Replaces Cumbersome Wood Blocks
-  Works with a Variety of Undermount Slides

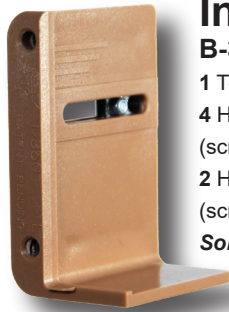

Inset Bracket, Handed*

B-393 Polybag

- 1 T-350-A and 1 T-350-01-A Handed Inset Brackets
- 4 HAR-079 #7 x 2" Washerhead Combo FT Type 17 Screw (screws for attaching bracket to cabinet)
- 2 HAR-113 #7 - 32 x 1/2" Machine Screw FHP (screws for attaching slide to bracket insert)

Sold 50 Polybags per Box

T-350-A (L) / T-350-01-A (R)

Bulk Box

Sold 100 parts per Box (100 Left or 100 Right)

For Bulk Orders, parts HAR-079 & HAR-113 will need to be purchased

Additional Hardware for Bulk Box Orders

B-391: HAR-079 (400)

B-545: HAR-113 (200)

**Works with most standard undermount slides. Not designed for elongated holes. Tenn-Tex Plastics recommends testing to fit before purchase.*



Inset Bracket, Universal*

B-394 Polybag

- 2 T-349-A Universal Inset Brackets
- 4 HAR-079 #7 x 2" Washerhead Combo FT Type 17 Screw (screws for attaching bracket to cabinet)
- 2 HAR-113 #7 - 32 x 1/2" Machine Screw FHP (screws for attaching slide to bracket insert)

Sold 50 Polybags per Box

T-349-A

Bulk Box

Sold 200 parts per Box

For Bulk Orders, parts HAR-079 & HAR-113 will need to be purchased

Additional Hardware for Bulk Box Orders

B-391: HAR-079 (400)

B-545: HAR-113 (200)

**Works with most standard undermount slides. Not designed for elongated holes. Tenn-Tex Plastics recommends testing to fit before purchase.*

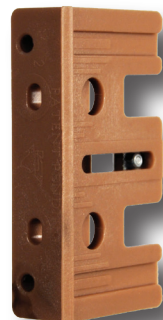

Inset Bracket, Universal* FOR BEADED FRAMES

B-427 Polybag

- 2 T-352-A Universal Inset Brackets
- 4 HAR-079 #7 x 2" Washerhead Combo FT Type 17 Screw (screws for attaching bracket to cabinet)
- 2 HAR-113 #7 - 32 x 1/2" Machine Screw FHP (screws for attaching slide to bracket insert)
- 4 HAR-083 #6 - 18 x 3/4" Trusshead Type 17 Screw (angled screw for beaded attachment)

Sold 50 Polybags per Box

T-352-A

Bulk Box

Sold 200 parts per Box

For Bulk Orders, parts HAR-079, HAR-113 & HAR-083 will need to be purchased

Additional Hardware for Bulk Box Orders

B-391: HAR-079 (400)

B-545: HAR-113 (200)

B-388 HAR-083 (400)

**Works with most standard undermount slides. Not designed for elongated holes. Tenn-Tex Plastics recommends testing to fit before purchase.*

Instructions

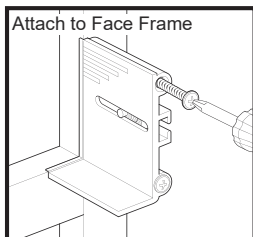

Attach any of the inset brackets to the faceframe with the HAR-079 screws.

Attach and secure the slide to the threaded insert with the HAR-113 machine screw

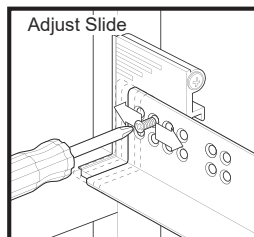

Additional side holes may be used on the T-352-A for extra support in a beaded inset application. Pre-Drilling is recommended.

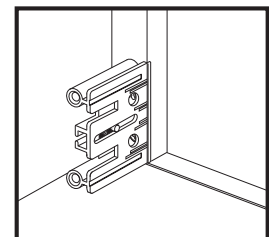
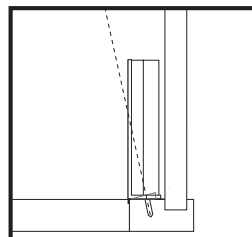

Rear Brackets for Inset Undermount Applications

Tenn-Tex Plastics has designed specialty Undermount Rear Brackets for Inset Applications. When you install the Front Inset Brackets, the Undermount Drawer Slide must be mounted further back in the cabinet. The standard Overlay Rear Brackets will not allow the drawer slide to move further into the cabinet. The Inset Back Brackets from Tenn-Tex will allow you to mount your slide within 13 mm of the back panel. The Brackets have over 17 mm of side to side adjustment. Our Inset Rear Brackets will work with most undermount drawer slides. They are available with dowels for multiple drill patterns or in a screw-on version. For more information and to solve your Bracket needs at contact us at **1-800-Tenn-Tex** or **sales@tenntex.com**.

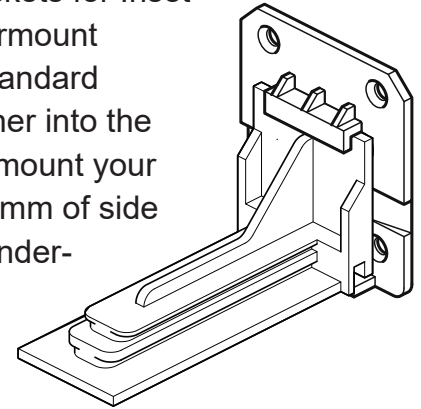

Common Item Numbers for Rear Brackets for Inset Applications. For additional parts, contact Tenn-Tex Plastics.

Item #	Attachment	Back	Drill Pattern	QTY
C-280	Screw-On		X = 1.5 / Y = 6.5	400 qty
C-308	8mm Dowel	1/8" Thick	X = 16 / Y = 3.5	400 qty
C-283 / C-283-01	10mm Dowels	1/4" Thick	X = 3.5 / Y = 8	400 qty
C-301 / C-301-01	10mm Dowels	1/8" Thick	X = 3.5 / Y = 8	400 qty
C-338 / C-338-01	10mm Dowels	1/4" Thick	X = 3.5 / Y = 3	400 qty
C-422 / C-422-01	10mm Dowels	1/8" Thick	X = 3.5 / Y = 3	400 qty

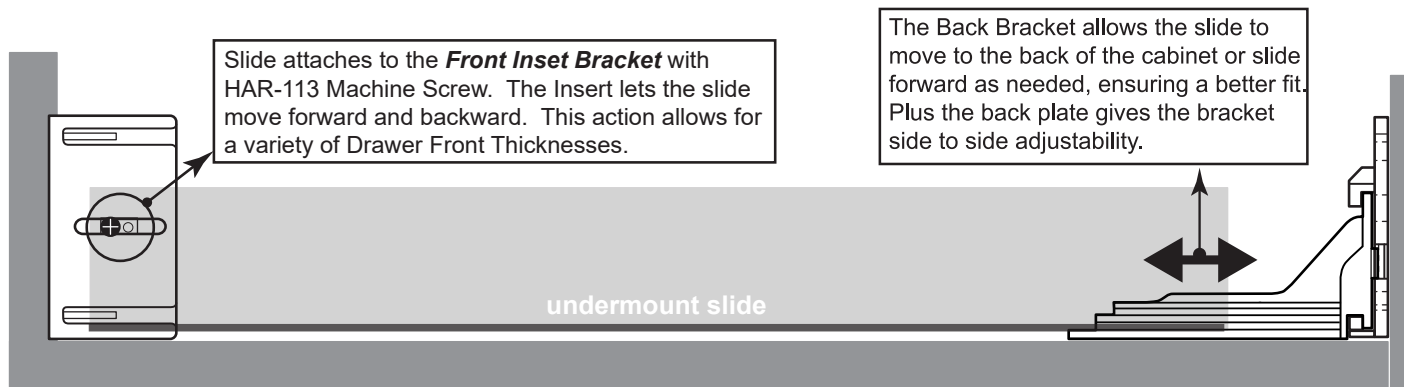

Adjustability

Tenn-Tex Plastics' Inset Brackets work with a wide range of drawer front styles and thicknesses. The T-349-A and T-352-A Brackets allow a drawer slide to be positioned into the cabinet for a thicker, beaded drawer front or allow it to rest on top of the stretcher rail for thinner profiles. The T-350-A/T-350-01-A automatically places the drawer slide further from the stretcher rail and gives it support for drawer fronts that are over 3/4" thick.

The TENN-TEX Plastics Advantage

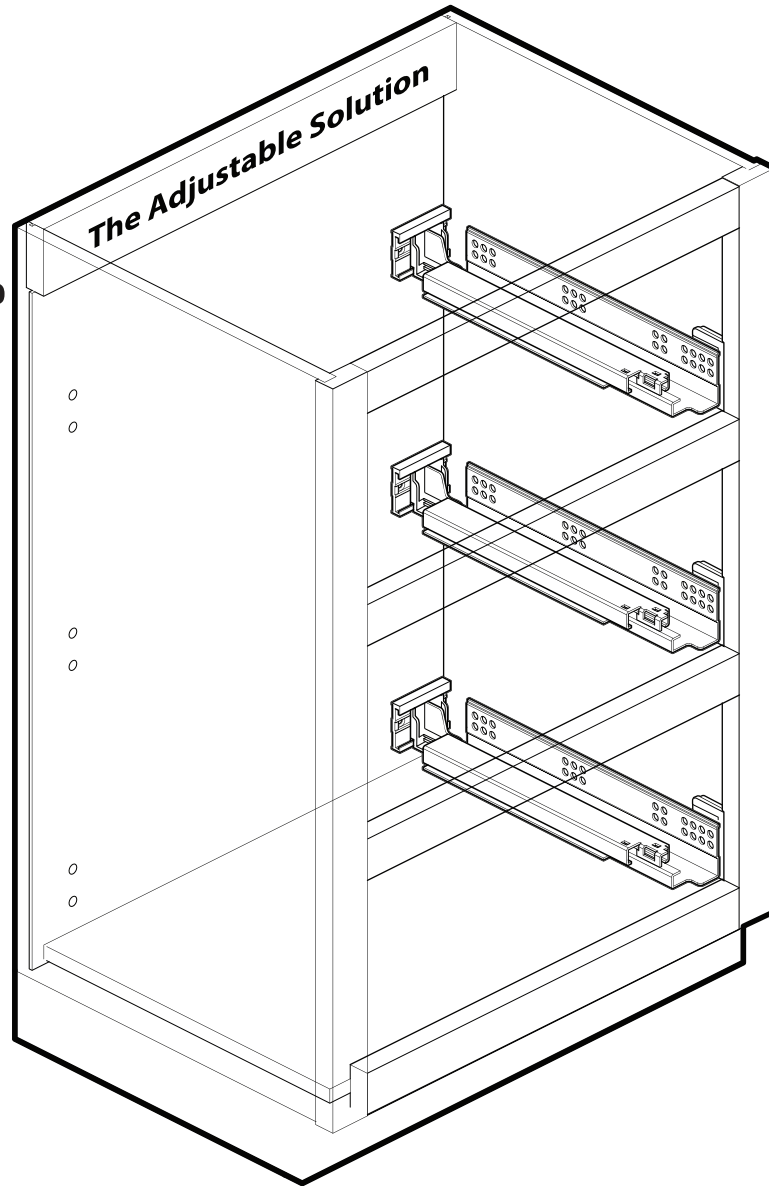

Inset BRACKETS the adjustable solution



1.800.TENN.TEX • 8011 National Service Road
Colfax, NC 27235 • WWW.TENNTEx.COM



Made in the USA



A Marmon Group/Berkshire Hathaway Company



AUGUST
2020

The parts contained in this brochure may be covered under patents held by Tenn-Tex Plastics, Inc.